

Finfloor



Flooring with
Durable
technology
for a home without limits

Our history

Here at **Finsa**, we've been dedicated to processing wood, designing and manufacturing decorative and technical solutions for your spaces for almost a hundred years.

We strive every day to address the needs of the interior design and construction sector by creating wood products and processing solid wood. Our processes ensure that the wood retains all of its qualities, while improving its efficiency through an industrial process based on the circular economy.

Design is in our DNA at Finsa: not only is it the linchpin of our product creation process, but it's also one of our key strengths as a brand. This catalogue acts as an inspirational guide, pushing the boundaries of design and the materials that will become part of the spaces we inhabit in the coming years.

We've been manufacturing laminate flooring for more than 20 years. At our factory in Lugo, Spain, we strive every day to make **Finfloor** a benchmark for quality materials in all projects, and are now one of the most recognised and reliable laminate flooring brands in the industry.

Finsa

Finfloor

Contents

04 Sustainability

06 Key differences between
some wood-based flooring
options

10 Why choose Durable
flooring?

12 Features

14 Connect
with Finfloor

16 Introduction

18 Inspiration

128 Application
overview

What else do you need to complete your installation?

132 Finfloor underlay

134 Accessories

138 Solution for
your stairs

Technical Information

140 Finishes

142 Plank
formats

144 Colour chart

Sustainability

We care about the environment

Wood products play a fundamental role in environmental conservation and enhancing the value of natural resources. That is why we're committed to sustainability, both when designing and executing our processes, and in our environmental policy.

In addition to respecting and protecting the forests, which are our main source of raw material, at Finsa we're working to go beyond the limits of our workplaces with the aim of contributing to environmental development, and that of its inhabitants.

Product certifications



Finfloor laminate flooring has the EU Ecolabel certification, a voluntary seal of environmental excellence for products or services created by the European Union in 1992, which guarantees that they meet high ecological standards throughout their life cycle.



Certification regulating formaldehyde emissions in composite wood products. Its purpose is to reduce formaldehyde exposure, thus positively influencing human health by ensuring the air that we breathe is clean and free from harmful carcinogens.



FSC® (FSC-C041397) chain of custody certification system allows us to supply certified wood products to customers, 100% recyclable and with a contribution to the fight against climate change. This forest certification promotes certified wood, and for this we certify our farms and help our suppliers achieve their certification.

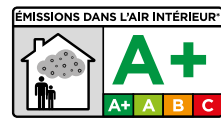

Sustainable building certifications



Zero-mile point of origin



Our laminate flooring is 100% manufactured in Galicia, Spain, and we're also committed to using local products, which is why practically all our wood comes from forests near the Fibranor factory.

Photograph taken in Galicia.

KEY DIFFERENCES BETWEEN SOME WOOD- BASED FLOORING OPTIONS

There are now countless different flooring options available for our homes: solid wood, three-ply or engineered, laminate, synthetic, glued-down or floating installation, etc.

It's normal to be unsure of the differences between the various options and get them mixed up, especially with so many confusing terms. So, we're going to try to shed some light on the matter, starting with the difference between natural wood and laminate flooring.

Solid wood or natural wood flooring

Solid wood flooring has a hardwood top layer with a minimum thickness of 2.5mm.

The most common species for this type of flooring include pine, ash, beech, cherry, iroko, jatoba, oak and walnut.

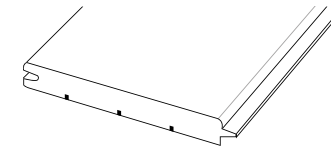

SOLID WOOD FLOORING

Solid wood planks of different sizes and thicknesses between 15mm and 30mm, with tongue and groove all around the outside.

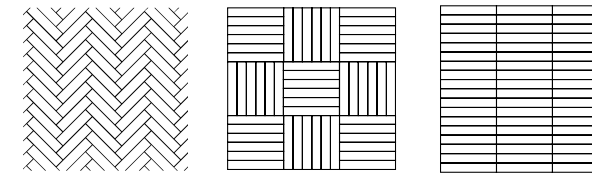

SLATTED PARQUET FLOORING

Small, usually rectangular solid wood planks measuring between 8mm and 14mm thick.

You can use different plank sizes and placements to create a variety of geometric patterns, such as mosaic, lamparquet and industrial parquet. Parquet flooring is installed by gluing it to the floor.

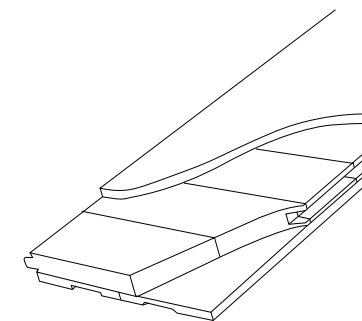

MULTILAYER OR THREE-PLY FLOORING

Also known as engineered wood, it's formed of several layers of bonded wood, with a usual thickness of around 14mm - 15mm.

- **Hardwood layer:** 2.5mm - 6mm thick and covered with several layers of varnish.
- **Core layer:** formed of cheaper woods (mainly pine or spruce), with the grain placed at a right angle to ensure the stability of the whole plank.
- **Base layer:** this layer is in direct contact with the floor and is usually made of pine.

TYPES OF INSTALLATION

GLUED-DOWN FLOORING:

All planks are glued to each other and to the floor.

BATTEN-MOUNTED FLOORING:

The planks are usually made of solid wood and are nailed onto wooden battens resting on the well-levelled floor.

FLOATING FLOORING:

The planks are laid on top of an underlay and are not glued or fixed at any point.

WHAT IS A FLOATING FLOOR?

A floating floor is simply flooring with a floating installation, i.e., it hasn't been glued to the floor. Although it should only be used for wooden flooring, the term has become widespread and is now often used to refer to all laminate flooring laid in this way.



Laminate flooring

Also known as synthetic or floating flooring, laminate flooring is formed of several bonded layers. The top layer is often textured to imitate the look and feel of real wood.

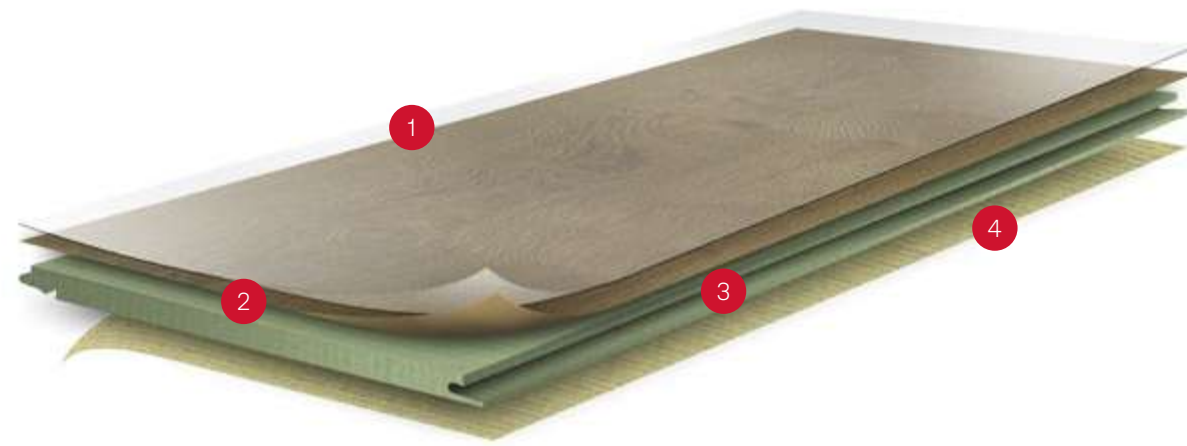

1

TOP LAYER (OR OVERLAY)

A thin, transparent layer resistant to wear and tear, sunlight, water, impact, knocks, scratches and burns.

2

DECORATIVE LAYER

A printed layer that faithfully reproduces all types of materials such as wood, stone, textiles and patterns, and their colours using sun-resistant inks.

3

HIGH-DENSITY FIBREBOARD

The core of the laminate flooring. The durability, dimensional stability and moisture resistance of the flooring will depend on the type of board used.

4

BASE LAYER

The bottom layer of the planks, which has two functions: to protect the fibreboard, and to act as a counterbalance to the upper layers.

Why choose laminate flooring?

HOW DO YOU INSTALL LAMINATE FLOORING? WITH A SIMPLE CLICK!

Laminate planks join together without the need for adhesives or other external elements. Their ingenious tongue and groove locking system allows them to fit together like a jigsaw. Thanks to this adhesive-free click system, laminate flooring can be installed on practically any surface (cement, wood, tiles, ceramic, etc.) without the need to fix it to the existing floor.

Prior to installation, it's essential to install an underlay to protect the floor from moisture and improve insulation, as well as dampening noise and correcting any minor floor levelling irregularities.

Laminate floors offer many advantages over other floors due to their installation system, easy maintenance, value for money, wide range of designs and textures, etc. Check it out:

	PARQUET	LAMINATE FLOORS
INSTALLATION	⊖	⊕
MAINTENANCE	⊖	⊕
DESIGN	⊕	⊕
COMFORT	⊕	⊕
STRENGTH	⊖	⊕
SUSTAINABILITY	⊕	⊕
VALUE FOR MONEY	⊖	⊕



AN INNOVATION THAT ENHANCES PROTECTION AGAINST MOISTURE.

Finfloor Durable PRO is the system born from the synergy between our most advanced technology, Finfloor Durable, and the innovative water protection treatment Unicoat, developed by Unilin Technologies. This treatment, applied to the tongue and groove of the slats, acts as an invisible and effective barrier against water, preventing leaks and preserving the aesthetic integrity of the joints even in situations of prolonged exposure to liquids. With this combination, Finfloor Durable PRO floors offer superior moisture resistance, greater durability, and improved everyday performance, without compromising the integrity of the material.

Tested water resistance in joints

Durable flooring is water-resistant, meeting the requirements of ISO 4760:2022. The new Durable PRO technology takes water resistance to the next level by incorporating additional protection into the tongue and groove system. This waterproofing barrier prevents water from penetrating the joints, ensuring the floor's resistance to long-term damage, even after 100 hours of exposure to liquids on the surface. Thanks to this improvement, Finfloor Durable PRO offers greater safety and comfort in everyday use, allowing the integrity and aesthetics of the joints to be preserved when the floor is exposed to prolonged contact with water. This is possible thanks to the experience gained from more than 40 years as MDF/HDF manufacturers and more than 25 years manufacturing Finfloor, thus achieving the highest quality standards throughout the entire process.

Finfloor Durable PRO in three collections

The Evolve, XL and 12 collections evolve into Finfloor Durable PRO, further elevating the performance of our laminate floors. Thanks to this innovation, we are moving into the future with greater strength, durability, and confidence in each installation, while always maintaining the design and warmth that characterise Finfloor.



48 hrs water resistant NALFA Test

BENEFITS

Finfloor flooring with Durable PRO technology has the following benefits:

- ◆ It's suitable for the most demanding spaces, even home kitchens and bathrooms, where there is water and moisture. Furthermore, installation in these rooms is just as easy as in any other space, as there's no need to use a sealant between planks, and it can provide a sense of continuity in all rooms of the house.
- ◆ You can install up to 12m x 12m (144m²) without the need for expansion profiles, even in doorways, which will give your entire project visual continuity.
- ◆ Our laminate flooring is suitable for commercial and high-traffic spaces with Class 33 usage level, and also complies with AC6, the highest market requirements for abrasion resistance.
- ◆ At Finfloor we're so confident in the performance, quality and resistance of our Durable PRO flooring that we offer a Lifetime guarantee for domestic use and a 10-year guarantee for bathrooms and kitchens.
- ◆ Tested water resistance in joints: meeting the requirements of ISO 4760:2022 and resists 100 hours of exposure to liquids on the surface.

Technical characteristics Durable technology

XL* | 12* | Evolve* | Supreme | Style Collections



Core



Durable
Low swelling HDF (< 8%)



Low formaldehyde
emission

Durability



Abrasion-resistant



Heavy Commercial.
Heavy Domestic
(EN 13329)



Suitable for
bathrooms and kitchens.
Domestic Use



Surface water resistance at joints:
Complies with ISO 4760:2022
standard and withstands up to 100
hours of standing water on joints.

Warranties



Check the warranty conditions included in the packs, in our website www.finfloor.com or scan the following QR code to access it directly.

Warranty covers all bevelled and non-bevelled products.

Technical characteristics

Original Collection

Core



Hydroprotect
High dimensional stability HDF



Low formaldehyde
emission

Durability



Abrasion-resistant



Surface water
resistance



Heavy Commercial.
Heavy Domestic
(EN 13329)



Suitable for
bathrooms and kitchens.
Domestic Use

Warranties



Check the warranty conditions included in the packs, in our website www.finfloor.com or scan the following QR code to access it directly.

Warranty covers all bevelled and non-bevelled products.

Security



Antistatic
(EN 14041/EN 1815)



Reaction to fire Bfl-s1
(EN 14041/EN 13501)

Installation



12 x 12 m installations
144 m² without profiles



Click System



Sealed Edges

Security



Antistatic
(EN 14041/EN 1815)



Reaction to fire Bfl-s1
(EN 14041/EN 13501)

Installation

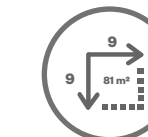

9 x 9 m installations
81 m² without profiles



Click System



Sealed Edges

Connect with Finfloor

Website



Our user-friendly website allows you to find the information you need easily, quickly and intuitively. You can use the Finfloor website to filter your selected designs, compare your favourites and get inspiration from photos of spaces where the floor is the star of the show. We're always adding new features to present all our products and services and help bring your ideas to life.

Visualiser



Choosing your perfect floor design has never been easier. With the Finfloor room visualiser you can compare different designs on your screen. Furthermore, thanks to the "Compare" mode, you can even view two designs in the same room at the same time. Not only can you get inspiration from our suggested room settings, you can also upload a photo of your actual room and change the floor design virtually to choose the one that best suits your style and taste. You can even change the direction of the installation! Endless options to find the design that best suits your space: bevelled, square edge, designer, etc.

Social Media



Follow us on Facebook and Instagram to learn more about us and keep up to date with all the latest news. You'll have access to everything from events, designs and inspiration to all the daily news from Finfloor. See you online!

Sample Service

You can't beat seeing something with your own two eyes. Check the map for your nearest retailer or distributor, where you can request samples and see the wide range of designs in the Finfloor collection.

Technical Support Team

Finsa's Technical Support Team of professionals has extensive experience in the field of architecture, interior design and construction projects. Their job is to assist you with your projects and advise you on wood solutions. We can even offer recommendations on partners to carry out your work, including specialist distributors, industrial suppliers and installers. We also have other tools and portfolios featuring projects using our materials to help inspire you with yours.

SET THE *MOOD* OF YOUR HOME

Feeling content, comfortable and in harmony is essential, and we're increasingly aware of how the spaces we live in can affect our mood. It's not just a matter of aesthetics, but of functionality too: homes, restaurants and hotel rooms all have different needs.

The materials, colours and textures around us all have an impact on our emotions, which is why at Finfloor, we strive to design flooring that promotes well-being in any space.

We're design experts and always have our finger on the pulse: we listen, analyse and adapt to trends thanks to the relationship we have with our clients, from end consumers to architecture practices to specialist stores.





● 69X Concrete
Dover

● 283B Sable Selena Oak
Wood Impression Selena

#natural #safespace
#biophilia #calm #light
#sanctuary #selfcare
#fluidity #wellbeing
#disconnect

Our living and workspaces have changed dramatically over the last two years. We've changed how we perceive our homes, which have become multifunctional spaces where we do much more than living. We now see them as our own personal sanctuary where we recharge the mind, body and soul.

Designed to promote harmony, self-care and healing, a room can become a place of health, wellbeing and serenity. The combination of neutral tones and natural materials can make a space feel cosy and relaxing. This philosophy goes hand in hand with a love of plants and nature, and as a result, connecting the inside with the outside has become one of the most popular trends.



Perfect fluidity

Without any divisions, light fills the rooms. The space becomes fluid, perfect for XL planks without the need for joints between doors.

Our **Century Vera Oak** design has 24 different planks, our largest laminate flooring surface without repetitions to date.

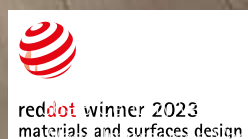

The living room, especially the sofa, has become the heart of the home. Is there anything better than sitting down to enjoy your favourite music or TV series in a relaxing space? With **Century Vera Oak**, you can turn your living room into a haven of wellbeing.

You can install up to 144m² without joints, even in doorways!
Our Durable PRO technology flooring is made with low-swelling HDF board (less than 8%) and has a lifetime guarantee in your home.



#natural #safespace
 #biophilia #calm #light
 #sanctuary #selfcare
 #fluidity #wellbeing
 #disconnect

Calm and wellbeing

#natural #safespace #biophilia
#calm #light #sanctuary
#selfcare #fluidity #wellbeing
#disconnect

Wood takes centre stage in coordinated, flowing rooms that convey a sense of calm.

The **Fado Gavia Oak** design hits the mark with its natural oak tone and subtle rustic synchronised texture.



Dream of a built-in dressing room?

Make your spaces flow by using the same laminate flooring in your bedroom and dressing room.

Let the outside in

Blurring the lines between the indoors and outdoors can turn your home into a cosy retreat, perfect for unwinding and relaxing while cooking.

The room combines a palette of warm, neutral tones with imperfectly rustic beige flooring, such as the synchronised texture of **Pardo Kalas Oak**.



#indooroutdoorconnection
 #minigarden #safespace
 #biophilia #calm #light
 #sanctuary #selfcare
 #fluidity #disconnect





In the search for clarity, transparent partitions bring in more light, which is further enhanced by light-coloured flooring. The muted tones, multi-format and synchronised design of **Sable Selena Oak** give spaces a more natural feel.

Natural clarity

#rest #safespace #calm
 #light #sanctuary
 #fluidity #wellbeing
 #disconnect #transition
 #wellbeing #neutraltones
 #pleasingpatterns



283B Sable Selena Oak
 Wood Impression Selena

Create your own pattern with the STYLE and SUPREME formats of the **Sable Selena Oak** design.

For example, two Style, one Supreme, one Style, three Supreme, and so on.

You'll create a highly realistic natural solid wood floor effect.

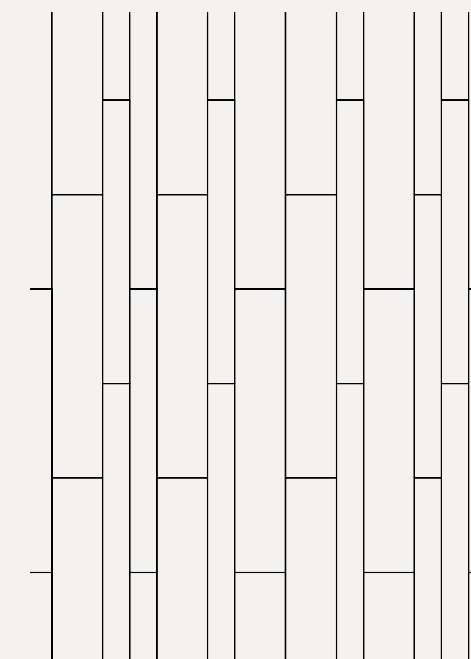
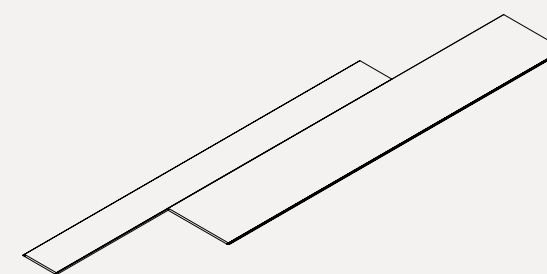

You can also enjoy a sense of comfort and wellbeing by going barefoot to feel the texture on your skin.

Everything in order

Your home environment has a direct influence on your wellbeing. Tidy, fluid, simple and minimalist spaces help promote a work-life balance.



341B Tavira Fado Oak
Wood Impression Fado



With its natural varnished oak tone, the **Tavira Fado Oak** design helps maintain the warmth of your home in your work environment, whether inside or outside your living space.



#workingfromhome
#order #flexibleliving
#calm #light #fluidity
#wellbeing #disconnect
#whiteneutraltones



How does working from home influence interior design?

Working from home puts flooring to the test, not only aesthetically but also technically. As office chair castors are constantly moving, you'll need abrasion-resistant flooring, such as **Tavira Fado Oak**, AC6.



• 336B Fado Gavia Oak
Wood Impression Fado

• 69X Concrete
Dover

• 283B Sable Selena Oak
Wood Impression Selena



#laundry #order #rest
#waterproof #safespace
#calm #light #sanctuary
#biophilia #wellbeing
#disconnect #urban

Urban nature

Biophilia is a huge trend in interior design, applied through shapes, materials, plants and neutral colours such as earth tones with green accents. Together, they create an ambience focused on health and wellbeing.

You need to make the most of every inch of your home, and designs with grey undertones such as our stripped **Twilight Oak** will help you coordinate your flooring in different spaces.



Enjoy the company of your pet and the warmth of wooden floors. With our laminate flooring, you no longer have to worry about your furry friends leaving their mark.

Resistant to knocks, scratches and moisture, it's also very easy to clean: simply mop or vacuum to remove hair and dirt. You can also disinfect our flooring and eliminate odours naturally by mopping with cleaning vinegar diluted in water.



69X Concrete
Dover

This space connects humans with nature through daylight, plants and natural organic materials.

Create simple, cosy spaces by coordinating your walls and wooden furniture with designs such as **Concrete**, with its new **Dover** stone-like texture.

Warm and
minimalist

Choose the combination you feel most comfortable with in your home.

If you prefer a minimalist space with clean lines and simple shapes, we have an alternative to skirting boards: our **end profiles** fit our flooring perfectly.

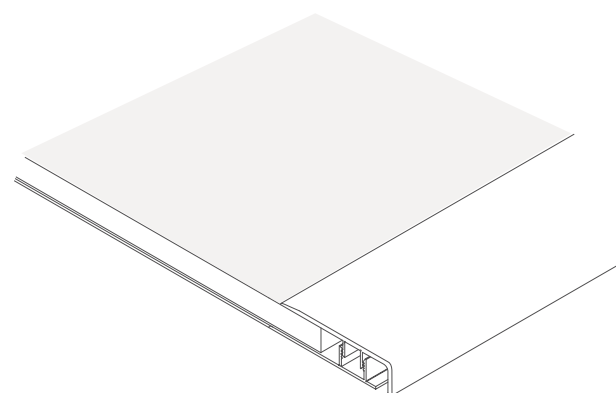

69X Concrete
Dover

#warmstone #minimalism
#order #flexibleliving
#indooroutdoorconnection
#natureretreat #calm #sanctuary
#wellbeing #disconnect



323B Crescendo Oak
Tibet

Cosy tranquillity



The warmth of **Crescendo Oak** in **Tibet** finish will add a realistic touch to your home with its beautiful knots and cathedrals.

Fill your space with plants to create your very own oasis where you can reconnect with yourself and nature.

#entrance #safespace #home
#order #bike #sport #resistance
#photography #calm #wellbeing
#disconnect



Want to leave your bike in the hallway?
Exercise in the living room? Have a party?
Go ahead. This flooring is non-slip,
hard-wearing and easy to clean.

• 283B Sable Selena Oak
Wood Impression Selena

• 336B Fado Gavia Oak
Wood Impression Fado

• 69X Concrete
Dover

Serene harmony

Choose the realism of wood but enjoy the resistance and easy maintenance of laminate flooring.

All Finfloor collections are **CLASS 33**: they're specially designed for heavy commercial use. Thanks to their high **AC6** resistance, your customers can sit and stand as much as they like, as the surface won't be damaged.

And thanks to our **Durable PRO technology**, they're perfect for open-plan spaces measuring up to 144m².

No need for joints!





The trend for light, calm and order also applies to public spaces.

The synchronised texture of **Sotavento Fado Oak** has a perfectly natural look that gives spaces a sense of tranquillity and harmony.

#cafe #socialising
#remoteworking #order
#differentfeelings #goingout
#calm #plentyoflight
#homefromhome
#pleasingpatterns #disconnect

Comfortable balance

Create an inviting space with organic elements designed for a relaxing yoga practice. Achieve a relaxed atmosphere by using materials that highlight their imperfections.

With the calming tone and restrained rusticity of the **Sonata Oak** design, your yogis will find that inner peace they're looking for.

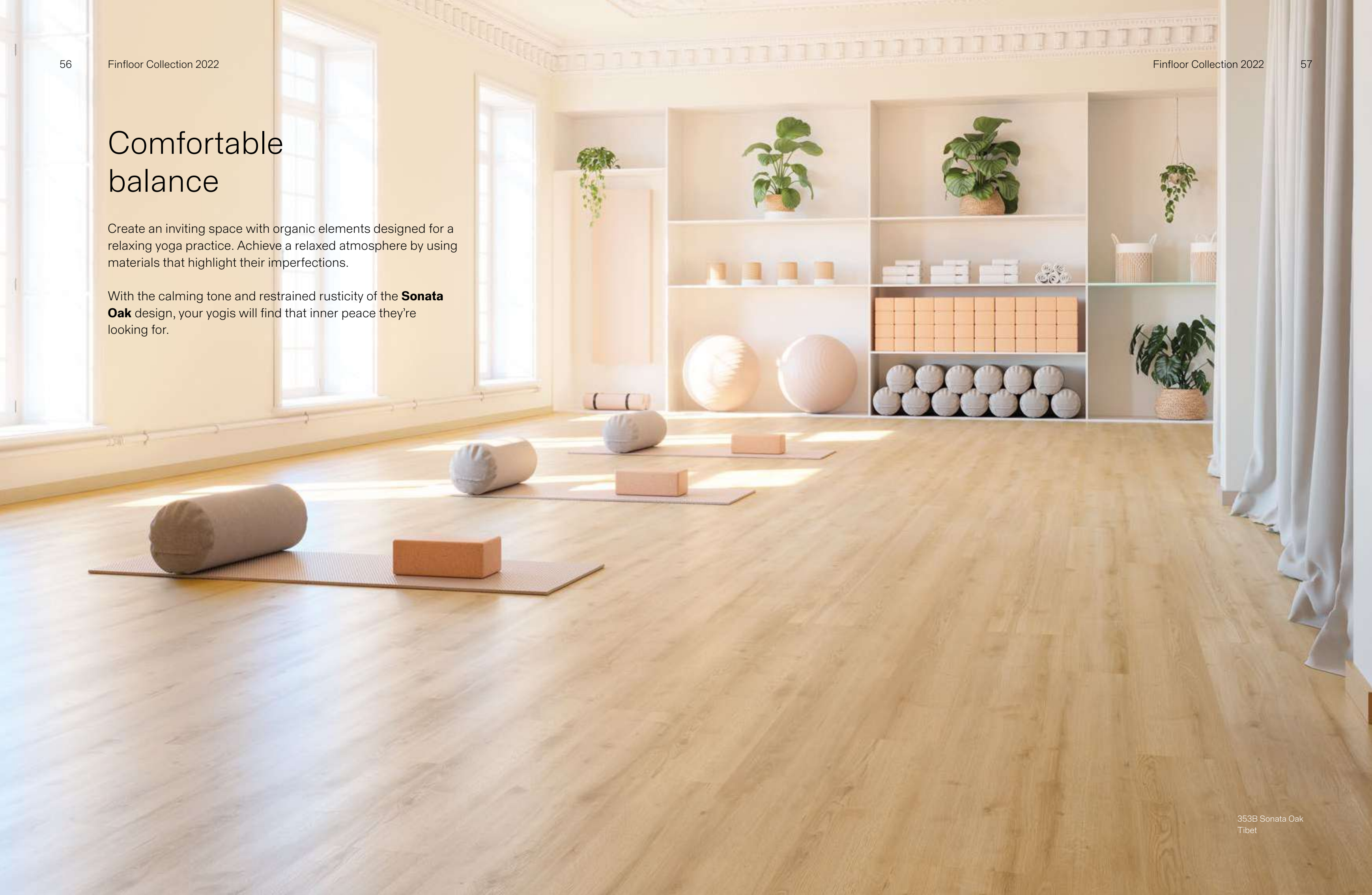



353B Sonata Oak
Tibet

Maximum wellbeing, even in winter.
Thanks to our **Finfloor Silent Elite underlay**,
our laminate flooring is certified for underfloor
heating systems and optimally transmits heat
throughout the room. So, you can kick off your
shoes whenever you want.

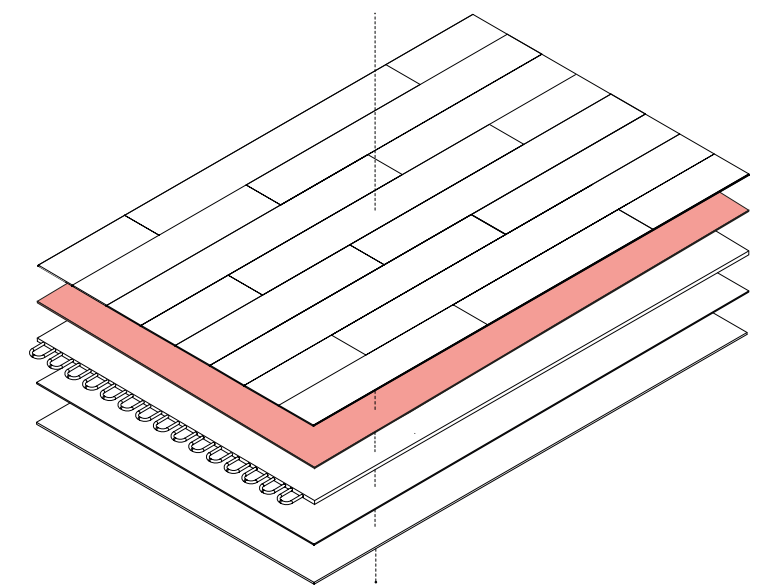

Relaxing and healing

Not only do we want the best service, we also want complete, unbeatable experiences. Pleasant materials and tones designed to promote balance, self-care and recovery are the most popular choice in spaces dedicated to healing.

The first step to create this ambience is choosing a design such as **Essence Kalmar Oak**: knot-free, raw with a slight greyish undertone and synchronised texture.

#clinic #mentalhealth
#order #neutraltones
#selfcare #safespace
#calm #light #sanctuary
#wellness #disconnect
#cleanknotfreefloors



Wood Impression synchronised textured floors provide all the realism of natural wood with the benefits of laminate flooring.





● 342B Polka Oak
Tibet

● 281B Dijon Chevron
Vintage Matt

#functionality #freshness #inventive
#primarycolours #versatile
#straightlines
#flexible #vibrant #optimistic
#charismatic #geometric
#newbauhaus #transformative
#colourblock

"Designing for happiness" is going to be a major interior design goal in the coming years. The aim is to **create unique, expressive spaces that can revive the mind, body and soul through design.** At the same time, rooms are also being transformed in a fun, modular way to optimise use and develop their potential as multifunctional spaces.

We're upping the style stakes by experimenting with shapes and objects, as well as playing with colour. The combination of saturated shades creates blocks of colour full of dynamic contrasts for a fresh, fun and optimistic feel.

Expressiveness and optimism

People want to create spaces where their own style shines through.

Rooms are becoming playgrounds of expressive shapes and colours, a fun way to escape and counteract the seriousness of the world outside.

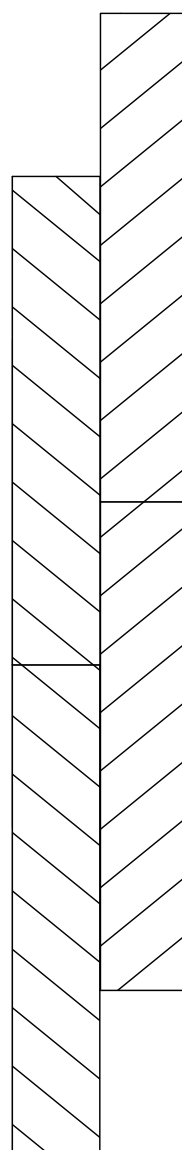

#animals #fun #ingenious
#primarycolours #versatile
#flexible #vibrant #optimistic
#charismatic

Golden woods, such as
Dijon Chevron, bring
energy and dynamism to
any room.

281B Dijon Chevron
Vintage Matt

The joints between the planks of our laminate flooring are perfect. Choose the herringbone format to make your floor more resistant and easier to maintain, even with pets.

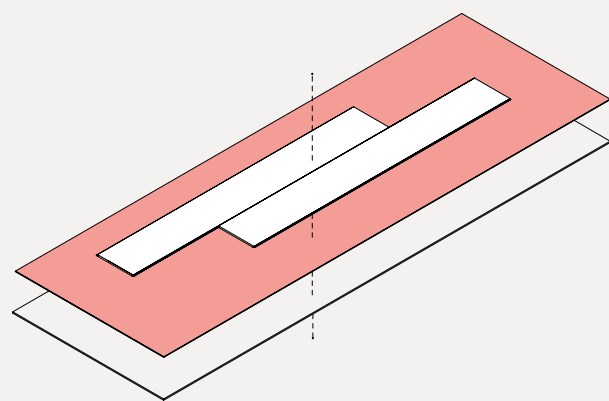

At Finfloor we also have three types of underlay to suit different needs. As **Finfloor thermal underlay** insulates your space, neither you nor your pet will notice temperature changes.



343B Brisa Fado Oak
Wood Impression Fado

As bold as it is functional

The designing for happiness trend can be applied to different rooms to create spaces that fill your mind, body and soul with energy.

Brisa Fado Oak is a light oak designed to add a natural finish and luminosity to any space.

The texture of the flooring is synchronised with the pattern of the wood to provide a highly realistic finish.

#kitchendiner
#functional #flexibleliving
#useofspace #primarycolours
#versatile #vibrant #optimistic
#colourblocking #geometric
#order

Choose our Durable technology laminate flooring for your kitchen and don't worry about a thing. It's resistant to moisture and a good silicone perimeter seal will make it leakproof.



In functional open-plan spaces designed for different activities, opt for white walls and add splashes of bold and bright colour through furniture and details.

That way, colour can play a key role in the identity of your space and add a touch of joy and optimism.

- 361B Golden Viena Oak
Wood Impression Gea

- 368B Tribute Vera Oak
Wood Impression Vera

- 342B Polka Oak
Tibet



Everyday, but far from ordinary.

Expressing your creativity through living spaces also applies to teen bedrooms. Choose fun furniture full of personality to create a unique room that energises the mind.

Simple shapes and bold, saturated colours add dynamism to spaces and vibrancy to everyday objects.

The golden tone and cathedrals of **Golden Viena Oak** gives a strong personality to a space. The pattern of the oak is synchronised with the texture of the flooring for a natural, realistic finish.

#youthroom #tennisplayer #hobbies
#sports #creativity #geometry
#primarycolours #homeschooling
#vibrant #optimistic #colourblocking





Fun and versatile

Kids' rooms are multifunctional and multipurpose spaces that need to evolve as the little ones grow, both in terms of use and the feelings they convey.

You can trust Finfloor to accompany you on this journey, as it has a 20-year guarantee for domestic use.

Furthermore, **Magari Oak** has a subtle raw oak tone with different colour intensities between the planks, just like solid wood flooring. You can give it a modern, cheerful twist by zoning different areas of the room with bold colours on the walls. Colour blocking is a fun and visual way to zone spaces that's bang on trend.



Playing, painting, running around... Kids never stop. That's why you need their space to feel safe. You can never be too careful.

Our laminate flooring is the perfect solution: it doesn't absorb dirt, it's totally hygienic, antibacterial and easy to clean.

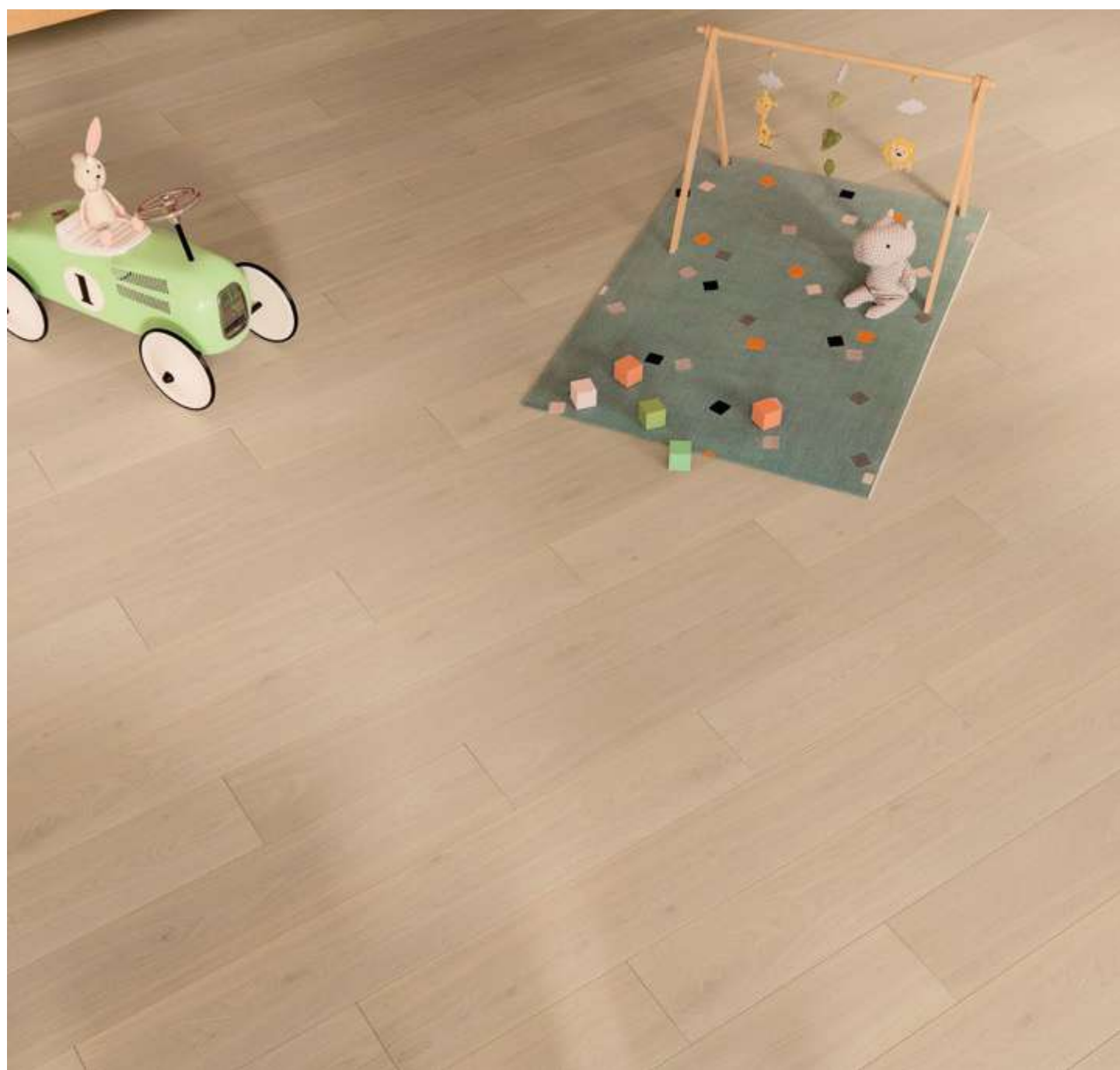

322B Magari Oak
Tibet

#kidsrooms #boldcolours
#imagination #creativity #joy
#different #creativepainting



367B Legacy Vera Oak
Wood Impression Vera

Traditional essence, avant-garde result.

When it comes to renovations, Finfloor is your ultimate ally. You'll save time with a quick and dry installation, while the wide variety of designs will give you the perfect look for your project. The golden-toned **Legacy Vera Oak** will maintain the historic feel of the space, while bright primary colours will create a fresh and cheerful ambience.

#shoeshop #sport #fun #straightlines
#geometry #catalanvault #expression
#creativity #cheerful #different
#primaryandpastelcolours #restoration

Our new range of **Vera** designs in **XL** format is available in five different shades. The five colours (24 non-repeating planks of 10.5m²) and synchronised finish give them a very natural look.

Perfect for open-plan spaces with a large visible floor surface!

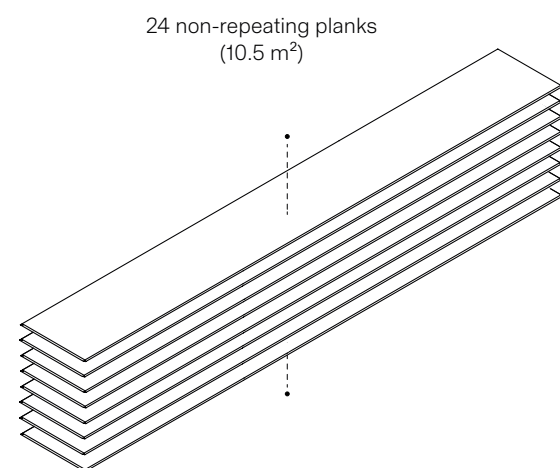

367B Legacy Vera Oak
Wood Impression Vera



Professional and motivating

Workplaces have completely changed and there is now a need for more flexible, versatile and dynamic spaces that energise.

Hybrid coworking models adapt to the needs of workers to offer creative, welcoming spaces.

Colour is used both functionally and emotionally to create a cheerful atmosphere. The best ally is the **XL Tribute Vera Oak** design, with its natural tone, synchronised pattern and 24 non-repeating planks.



reddot winner 2023
materials and surfaces design

368B Tribute Vera Oak
Wood Impression Vera

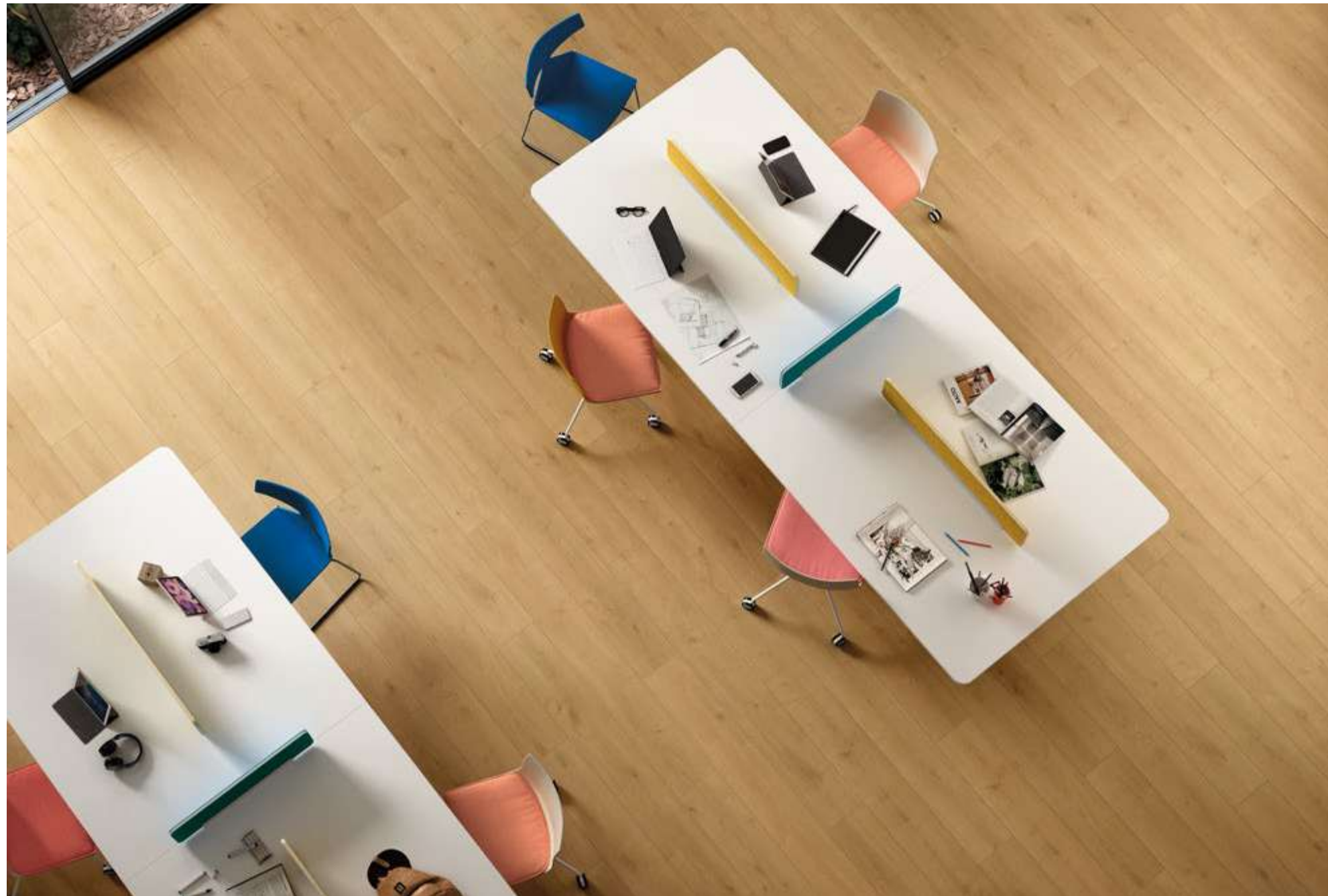

368B Tribute Vera Oak
Wood Impression Vera

Want to renovate your workplace or company without losing any time? It's now possible with our laminate flooring!

Its **click system** allows a quick, easy and dry installation. There's no need to remove your existing flooring and, as it doesn't involve gluing or varnishing, once fitted it can be used immediately.

#coworking #differentworkspaces #dynamisation
#optimisation #socialising #optimisingtheworkplace
#zoneyourhomeworkspace #joy #different
#colourblocking



● 18X Tasmanian Teak
Vintage Matt

● 366B Sweetness Vera Oak
Wood Impression Vera

● 312B Noz Kalas Oak
Wood Impression Kalas

● 324B Minueto Walnut
Vintage Matt

#nostalgia #lookingback #newretro
#luxury #eccentric #exclusivity
#contemporary #sophisticated
#darktones #warmmetals #escape
#unique #exuberant #carameltones
#vintageproduct

A general sense of nostalgia is influencing the lifestyles of people who, in contrast to the uncertainty of the future, long for the comfort and peace of mind of the past.

Spaces are becoming unique, breathing new life into items and concepts from previous decades to achieve a retro look. **Metallic colours, golden tones and exotic hard woods add a unique, sophisticated and evocative character to rooms.** Their personality is further enhanced by shapes and bold colours, with the occasional exception of pastel shades.



Interior design that evokes the peace of mind and comfort of bygone times helps us cope with more challenging periods. As an emotional tool, nostalgia provides wellbeing and has powerful healing properties.

The **Minueto Walnut** design echoes the elegance and refined charm of the luxury décor of yesteryear.

324B Minueto Walnut
Vintage Matt

Evocative sophistication



324B Minueto Walnut
Vintage Matt

#transition #kitchen #livingroom
#diningroom #luxury #nostalgia
#exclusivity #contemporary
#sophisticated #darktones

To install laminate flooring in the kitchen with total peace of mind, you can choose from any of the Original collection designs, as long as you use a joint sealant. With our **Durable (Supreme or Style) and Durable PRO (XL, Evolve or 12) technology** you can skip this step; it isn't required for leak-proof installation.

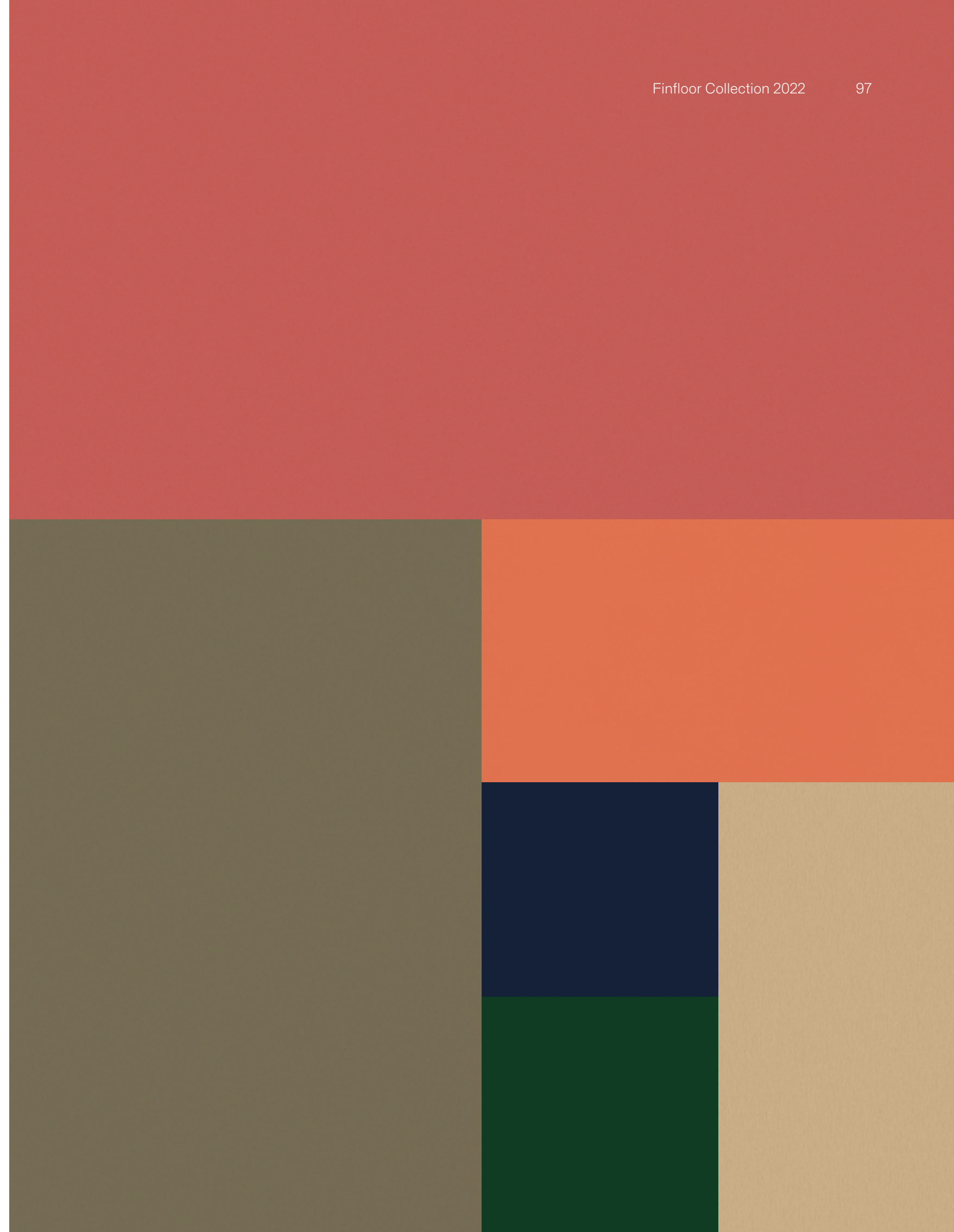



Memories and feelings

Items and furniture that evoke fond memories of childhood or times gone by create more authentic spaces and a comforting, homely feel.

Almost an antidote to minimalism, the **Belle Epoque Winter** design achieves this effect.



#kitchenisland
#retro #luxury
#nostalgia

The charm of ceramic tiles with the new **Dover** stone finish creates a room full of character.



Splashes? No worries.

Our laminate flooring is waterproof thanks to our Durable technology.

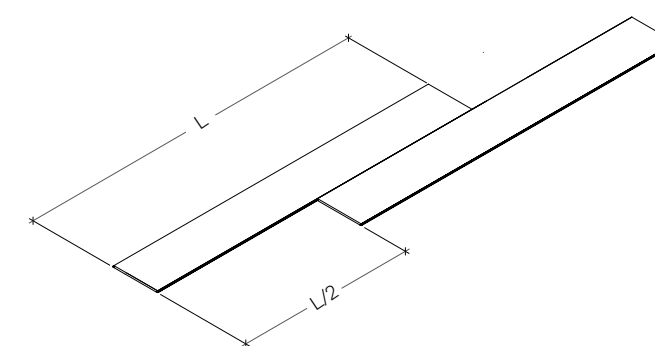

To create the perfect tile grid, lay the planks halfway lengthways during installation. In principle, the second plank should start from the middle of the first plank.

Retro modernity

The general sense of nostalgia also influences interior design and continues to drive a look inspired by the classics of the last century. Tried and tested models, updated reissues and revived iconic ranges have been key over the last few seasons.



Neutral grey designs can effortlessly modernise spaces.

They can provide a sense of continuity between rooms. If you have open-plan spaces in your home, **Grey Eyre Oak** is the perfect choice.

This design expands our XL EYRE oak collection with synchronised textured finishes.



#waitingroom #care #retroluxe
 #semicircularches #luxury
 #nostalgia #carameltones #grey
 #exclusivity

Use the Grey Eyre Oak **stair nosing** for your stairs: it integrates the different spaces in your home and gives a natural continuity to floors. It fits all types of steps and stairs and since it's made from the same material as the flooring, it's just as resistant.

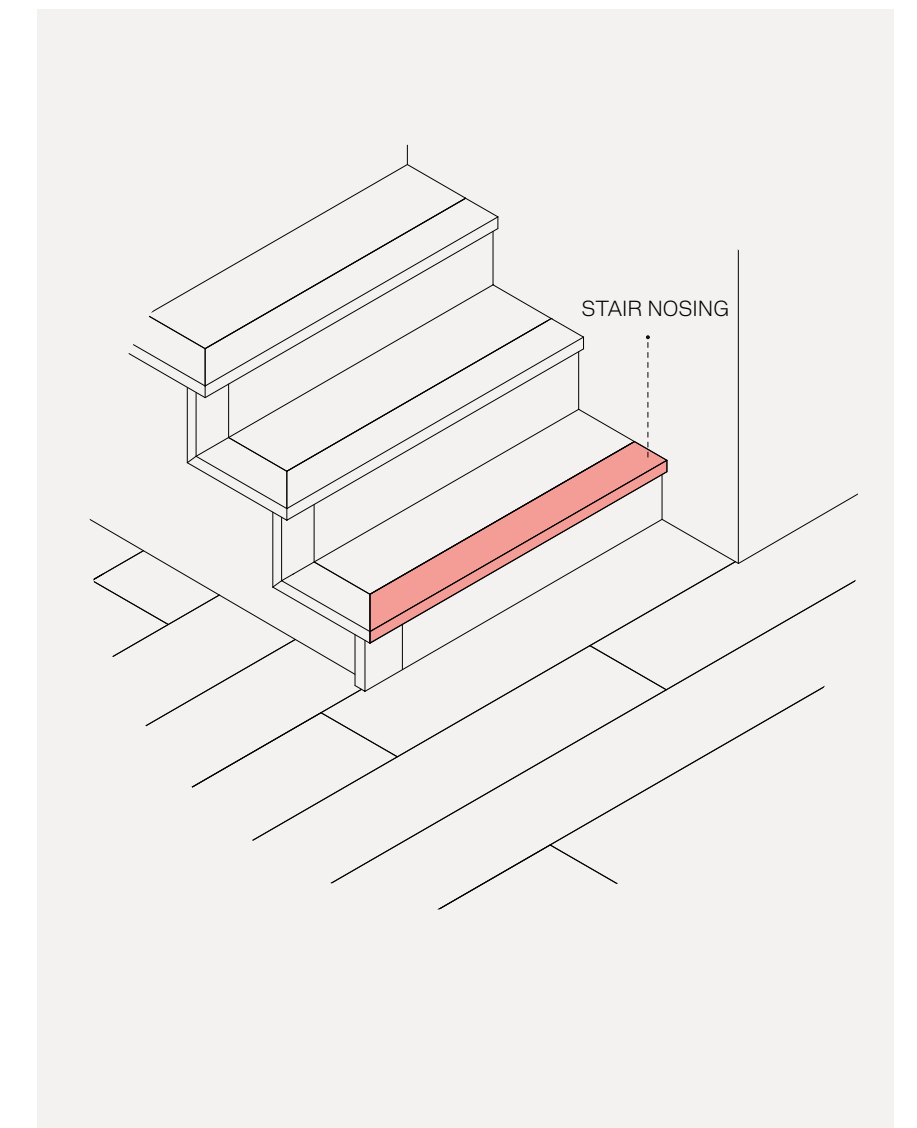

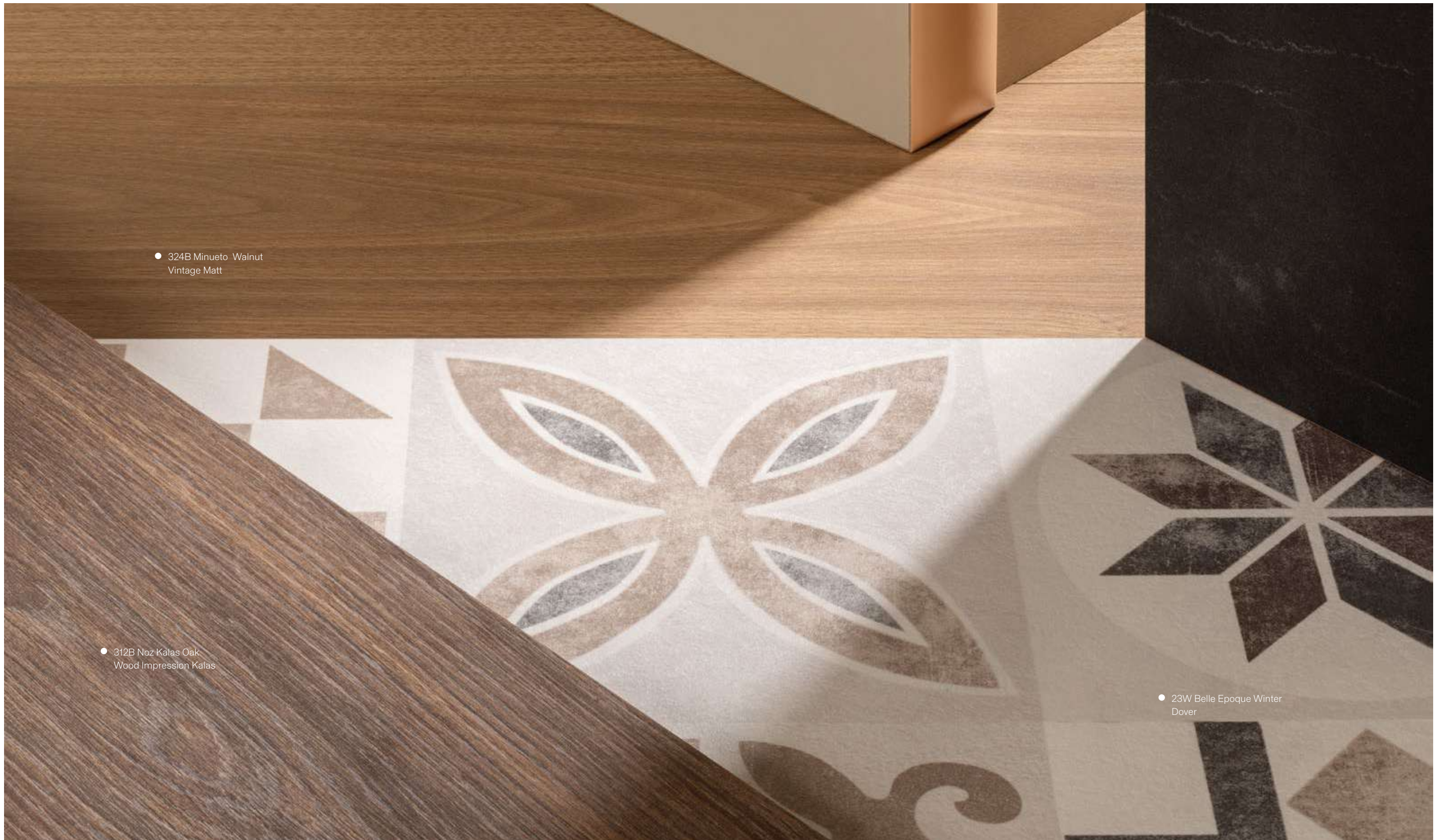

● 324B Minueto Walnut
Vintage Matt

● 312B Noz Kalas Oak
Wood Impression Kalas

● 23W Belle Epoque Winter
Dover



282B Nantes Chevron
Vintage Matt

Geometric nostalgia

The reassuring power of nostalgia can be seen in the growing interest in retro designs and spaces. The 1970s are leading this trend with their more refined style.

Geometric patterns such as those in the caramel-toned **Nantes Chevron** design are all the rage.



Our laminated flooring with **Durable technology** is totally suitable for wet environments such as bathrooms. Installation is just as quick and easy as in other rooms, just apply silicone around the edge. This completely seals the space and creates a watertight surface that blocks any potential leaks. Our flooring has a 10-year guarantee in wet environments.

#bathroom #luxuryselfcare
#personal #geometricshapes
#exclusivity #routines



Style and light

Achieve a look with a pleasing sense of comfort and retro sophistication by using refined grey tones and contemporary ribbed textures.

With its lovely natural tone and ultra-matt synchronised texture, **Sweetness Vera Oak** is the perfect light base for hotel rooms. It's also a design from the **Vera** collection, with **24 different XL planks**.



366B Sweetness Vera Oak
Wood Impression Vera



A floor that's suitcase-wheel-proof, easy to clean, comfortable...
Hotel floors are put to the test, but with the **AC6** high-abrasion resistance of our **Sweetness Vera Oak**, you can rest easy and relax with peace of mind.

#lookingback
#metallic #nostalgia
#sophisticatedtones #ribbed
#hotel #bedroom #retroluxe
#light



312B Noz Kalas Oak
Wood Impression Kalas

Comforting and enveloping

The trend of returning to the certainty of the past is also big in dining. Round arches are the emblem of this new look.

Thanks to its synchronised texture and smart dark tone, the **Noz Kalas Oak** design will give your business an air of cosy sophistication.

If your establishment has large spaces, choose a dark colour, such as **Noz Kalas Oak**.

Combined with mid-toned walls, sophisticated details and geometric shapes, it creates an intimate and enveloping ambience with a retro personality.

Our laminate flooring doesn't fade in sunlight: the intensity and shades of the colour will always remain the same as the day it was installed.



#restaurant
#deluxedining #intimacy
#comfortingambience
#lookingback #arches
#nostalgia



Restrained luxury

The retro aesthetics of the 1970s can also be seen in hotel lobbies with designs such as **Clarity Vera Oak**, a suitably light counterpoint to combine with sophisticated colour palettes in shades of green and red.

Hotel lobbies and reception areas are busy spaces, a meeting point with constant foot traffic.

Choose our Finfloor laminate flooring for total peace of mind. It's designed for commercial facilities with heavy traffic (CLASS 33) and is highly resistant to abrasion and wear (AC6).

It's also Bfl-s1 certified for reaction to fire and meets all CTE fire safety requirements.



reddot winner 2023
materials and surfaces design

365B Clarity Vera Oak
Wood Impression Vera



#hotel #lobby #socialising
#circulargeometricshapes
#connectingwiththepast #luxury
#lushplants #panelling



Summary of applications

FINFLOOR XL



Pag. 22 369B Century Vera Oak Wood Impression



Pag. 88 367B Legacy Vera Oak Wood Impression



Pag. 92 368B Tribute Vera Oak Wood Impression



Pag. 111 279B Grey Eyre Oak Wood Impression



Pag. 121 366B Sweetness Vera Oak Wood Impression



Pag. 128 365B Clarity Vera Oak Wood Impression

FINFLOOR EVOLVE



Pag. 36 341B Tavira Fado Oak Wood Impression



Pag. 44 69X Concrete Dover



Pag. 106 23W Belle Epoque Winter Dover

FINFLOOR EVOLVE | 12



Pag. 24 336B Tavira Fado Oak Wood Impression



Pag. 28 313B Pardo Kalas Oak Wood Impression



Pag. 41 36X Twilight Oak Wood Impression



Pag. 52 339B Sotavento Fado Oak Wood Impression



Pag. 61 352B Essence Kalmar Oak Wood Impression



Pag. 74 343B Brisa Fado Oak Wood Impression



Pag. 80 361B Golden Viena Oak Wood Impression



Pag. 124 312B Noz Kalas Oak Wood Impression

FINFLOOR STYLE | SUPREME



Pag. 30 283B Sable Selena Oak
Wood Impression

FINFLOOR SUPREME



Pag. 66 281B Dijon Chevron
Vintage Matt



Pag. 116 282B Nantes Chevron
Vintage Matt

FINFLOOR ORIGINAL



Pag. 48 323B Crescendo Oak
Tibet



Pag. 57 353B Sonata Oak
Tibet

Pag. 70 342B Polka Oak
Tibet



Pag. 84 322B Magari Oak
Tibet



Pag. 98 324B Minueto Walnut
Vintage Matt

Pag. 102 18X Tasmanian Teak
Vintage Matt

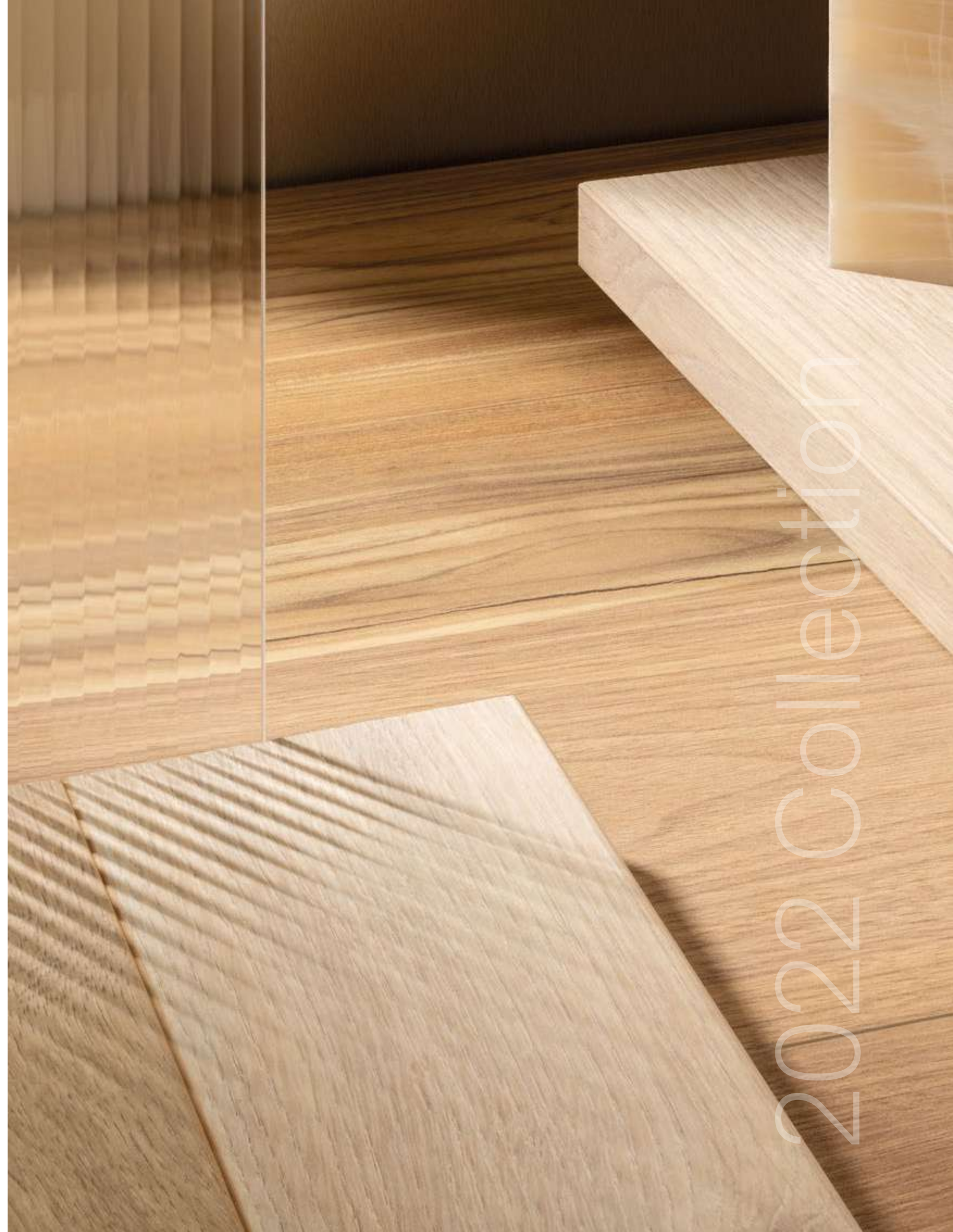

2022 Collection

What else do you
need for your
laminated floor?

FINFLOOR UNDERLAYS

Greater durability and comfort for your floor

The underlay is the insulating base on which the laminate floor is installed. Its main function is to protect your floor so that it remains in the best conditions over time. All our underlays protect your laminate floor from humidity and condensation from the subfloor thanks to their built-in plastic film.

We offer you three types of underlays so that you can choose the one that best suits your project:



Silent Elite underlay

The SILENT ELITE option reduces the noise transmitted to the floor below and the sound of footsteps, making it more pleasant. It also guarantees the useful life of the floor thanks to its levelling power, limiting deformation and maintaining the performance of the floor for longer. It is certified for use with radiant water heating or cooling systems, as its low thermal resistance allows for optimal heat and cold diffusion. Reduced roll sizes (20 m²) for less waste during small renovations.

Thermo underlay

The THERMO option top features include high thermal insulation capacity, meaning that temperature variations are less noticeable in your home. Reduced roll size (20 m²) for less waste during small renovations. This underlay is not suitable for radiant heaters.

New Essential underlay

Standard performance option, ideal for tight budgets or less demanding requirements. Its built-in plastic film protects your laminate floor from moisture and condensation from the underlay. Reduced size rolls (30m²) for less waste during small renovations.

	SILENT ELITE	THERMO	NEW ESSENTIAL
Thickness	2 mm	2 mm	2 mm
Length	20 m	20 m	25 m
Width	1 m	1 m	1,2 m
Density	130 Kg/m ³	35-40 Kg/m ³	35-40 Kg/m ³

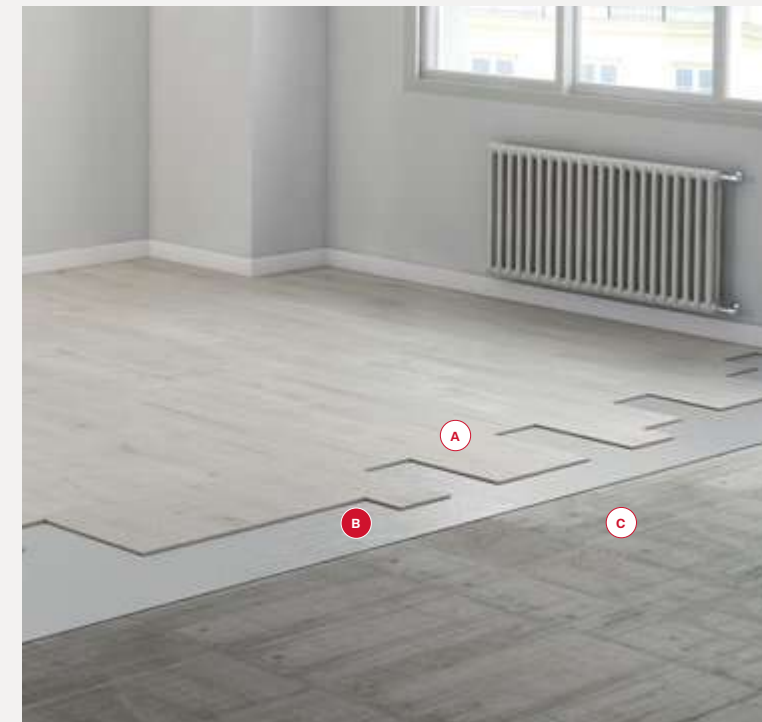

A FINFLOOR B FINFLOOR THERMO UNDERLAY C SUB-FLOOR

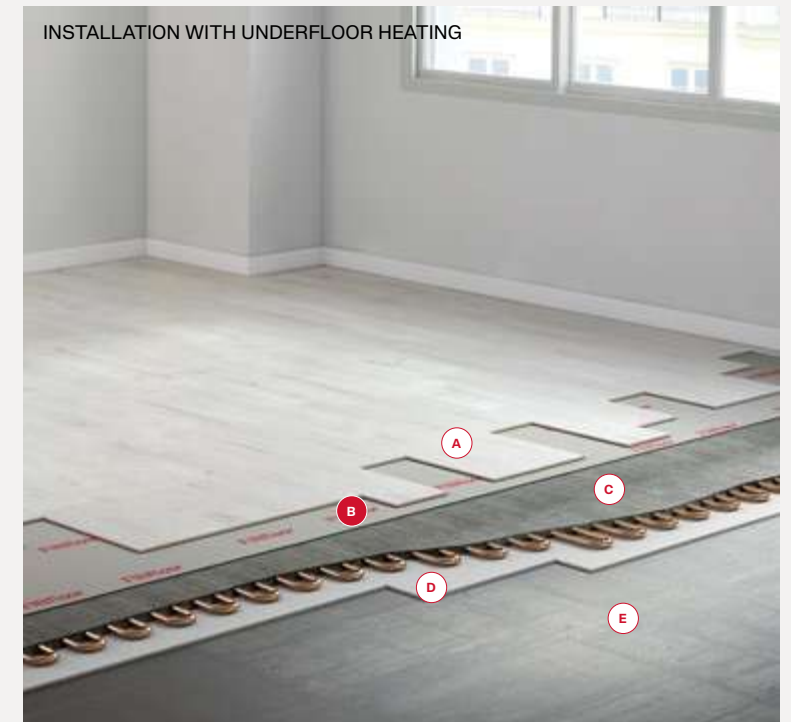

A FINFLOOR B FINFLOOR SILENT ELITE UNDERLAY C UNDERFLOOR HEATING D INSULATION E SUB-FLOOR

	SILENT ELITE	THERMO	NEW ESSENTIAL
Reflected walking Sound insulation	***	**	*
Impact sound insulation	***	**	*
Protection against loads	***	**	*
Protection against falling objects	**	***	**
Thermal insulation		***	*
Protection against moisture	***	***	**
Suitable for underfloor heating	✓	✗	✓

ACCESSORIES

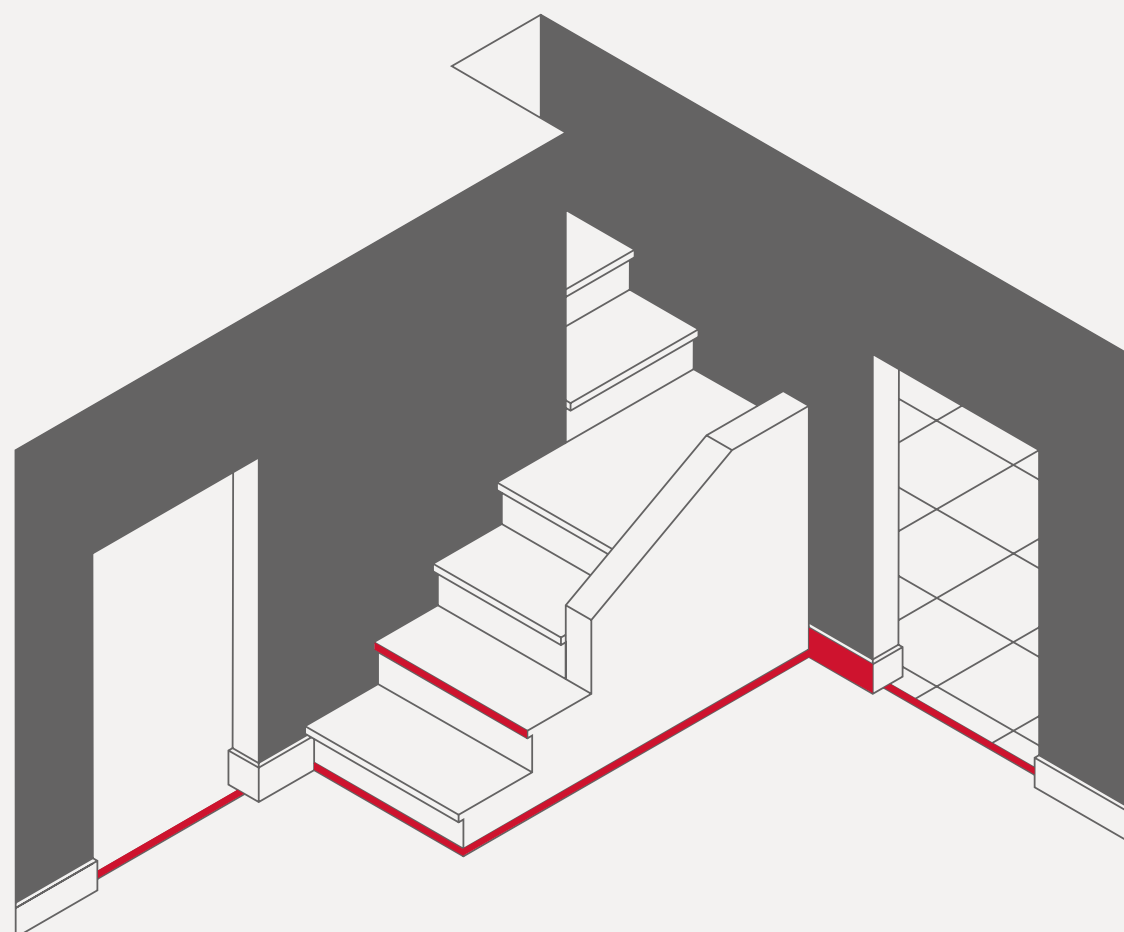

FINFLOOR IN BATHROOMS AND KITCHENS

The Finfloor collections with Durable PRO technology are prepared for demanding humid environments and their installation is very simple, only requiring the use of the perimeter silicone. Using the joint sealant and perimeter silicone, the Original collection is also completely suitable for installation in this type of space.



Perimeter application silicone

The neutral silicone filler prevents water seepage under floating floors in kitchen or bathroom installations. It is especially suitable for filling the expansion joint between the floating floor and the walls, furniture or bathroom fittings. Its high level of elasticity allows the floor to expand without losing its watertightness. Good adhesion on building materials such as concrete, cement, brick, natural stone, metals, wood, fibre backing boards, PVC or glass. Its application helps to prolong the life of the product and allows the use of Finfloor in kitchens and bathrooms with its corresponding guarantee.



Joint sealant

The joint sealant blocks water seepage between the laminate floor planks and prevents further damage to the installation. Its application helps to prolong the life of the product and allows the use of Finfloor in kitchens and bathrooms with its corresponding guarantee.

ALUMINIUM PROFILES

- ✓ Enhanced durability, hardly protrudes 1 mm.
- ✓ Length of 2,400 mm for clip installation (includes the base).
- ✓ The design adapts to the floor and complements it.
- ✓ Available for all our collections.

Expansion profile

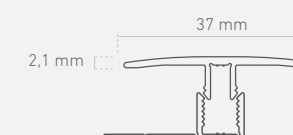

For use in doorways and when the dimensions of the room require it. It is designed to facilitate the expansion and contraction of the floor.

Transition profile

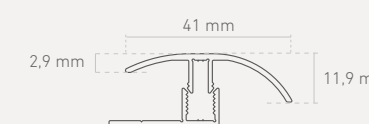

To be used when the installation of your laminate floor incorporates a union with a floor of a different height.

End profile

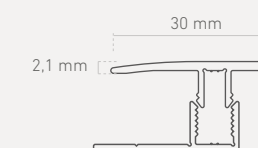

To be used when you want to finish off your installation with little or no protrusion. Very useful when finishing against a window or against furniture baseboards or bathroom fixtures.

SKIRTING BOARD

White skirting board

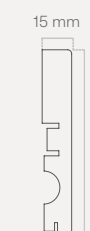

An essential complement to finish off a wall-based installation. Its straightf and modern design fits every floor. Made of moisture-resistant MDF. Includes cable grommet and snap-on system for easy installation.

Skirting assembly clip

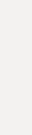

Necessary accessory to facilitate the installation of the skirting board by means of the snap-on system. Avoids the use of glue or nails on the skirting board itself. Installation of a clip every 40 cm of skirting board.

Colour-matched skirting board

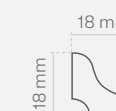

End cap for applications where the usual 70 or 90 mm skirting boards is too high (e.g.: joints with sliding doors of wardrobes, galleries, doors and balcony doors, or where furniture bases are incorporated, etc.) Made of moisture-resistant MDF.

SOLUTION FOR YOUR STAIRS

Our nosing adds the finishing touch to your rooms with steps or stairs, blending with the design you select for your floor. And, since it is a laminate floor, it provides many advantages:



Perfect finish and easy fitting

The design is identical and, since they are manufactured together, the nosing is as strong as the floor.



No protrusion

The surface remains flat and homogeneous.



Design continuity

The floor and the stairway produce a unified effect in the room.



Versatile

Adapts to all step sizes and stairway forms.



Maintenance

Very easy to clean.



High resistance

Resistant to blows, abrasion, wear and moisture.



Various finishing-off options

Provides different finishing touches.

Technical
Information

FINFLOOR FINISHES

Full matte? Better with a satin finish? With or without knots? The following table shows the finishes you can choose from depending on the gloss and the texture of the wood. So now you can learn about your new laminate FINfloor to the very last detail.

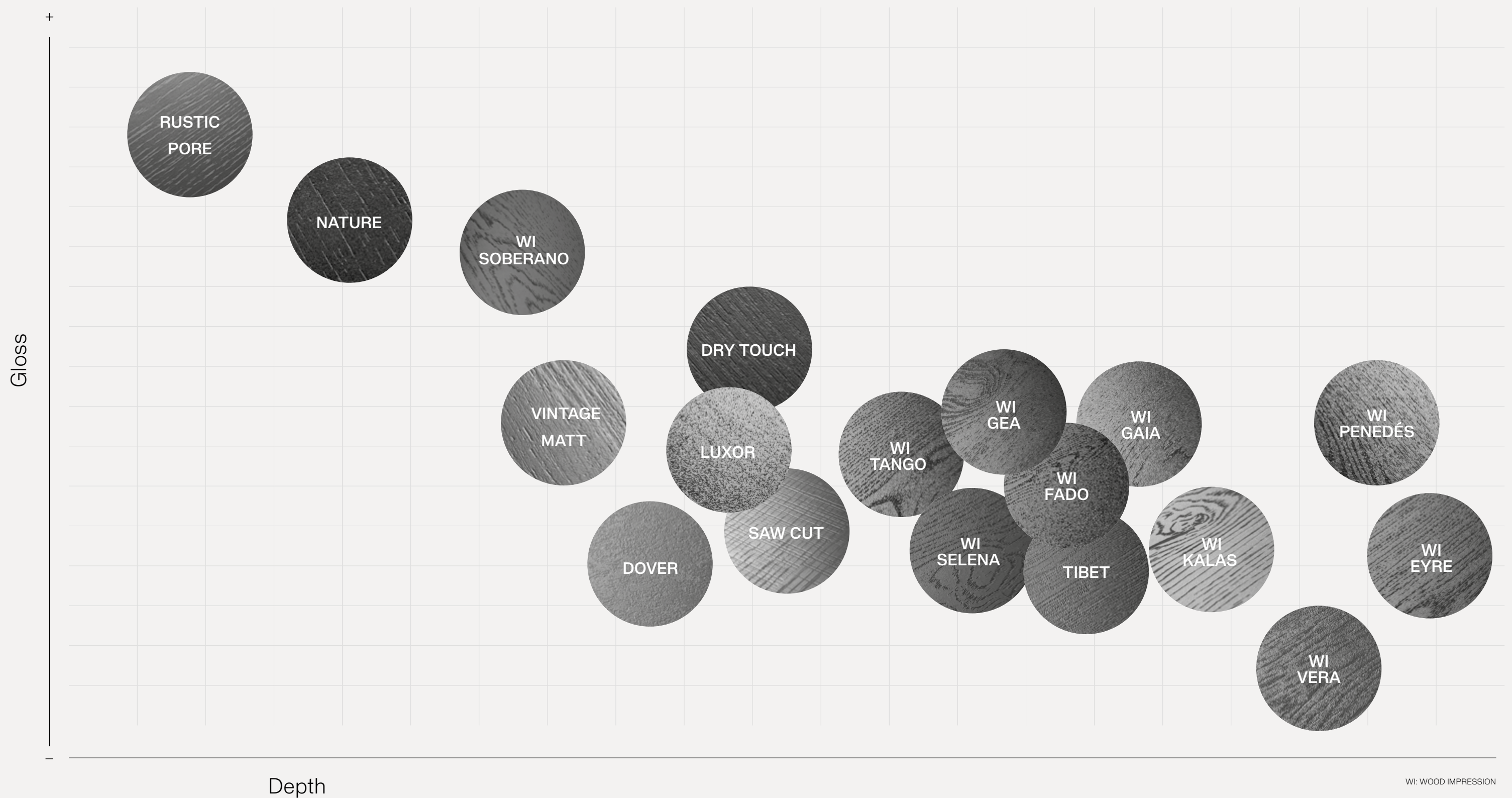

SELECT THE FORMAT OF YOUR LAMINATE FLOOR

Slimline, extra wide, XL size... These are the formats we provide to enable you to choose every last detail of your Finfloor laminate floor.

<p>12</p> <p>Greater thickness for the sound of solid wood and greater strength.</p>	<p>Original</p> <p>The widest range in the traditional 19 cm width that adapts to all styles.</p>	<p>Supreme</p> <p>Collection of designs with a "noble" width of 24 cm that achieves the look of natural wood boards.</p>
<p>Evolve</p> <p>The collection of standard format proportioned between length and width that adapts to all sizes of spaces.</p>	<p>Style</p> <p>The extra slim format with 13 cm-wide planks.</p>	<p>XL</p> <p>Extra-long format to create unique rooms with a marked personality. The planks provide the feeling of greater spaciousness and natural wood.</p>

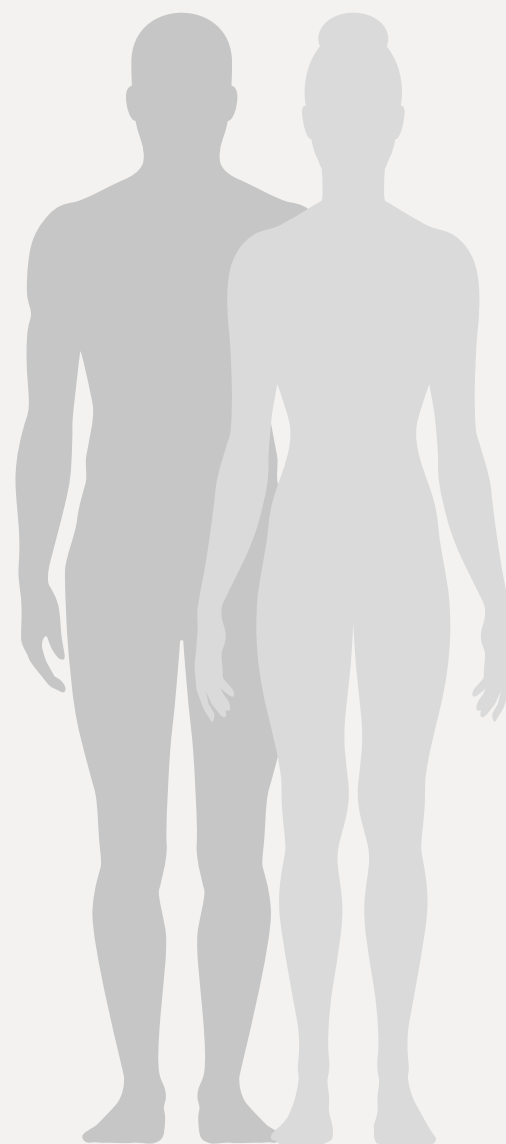
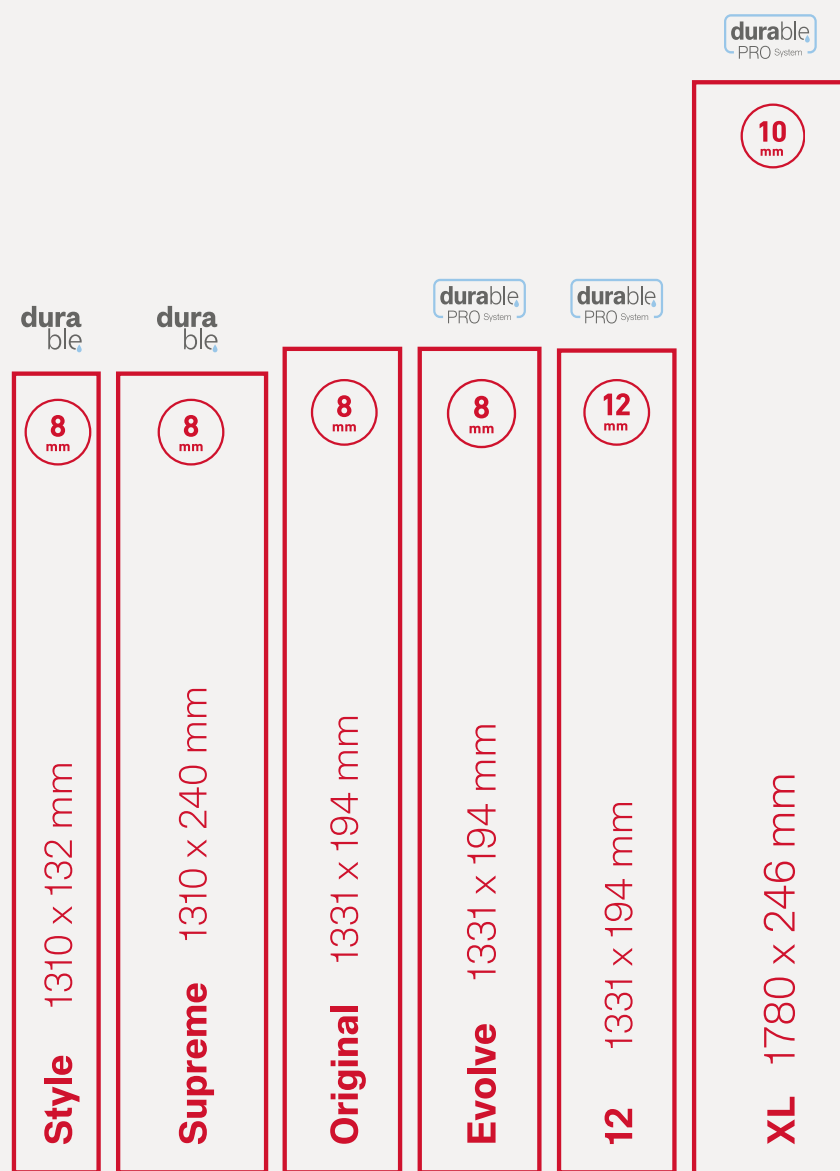

HOW TO INTERPRET THE DESIGN ICONS

There is a lot of information you need to know in each design: texture, bevel type, plank design and design specifications. We have summarised this information in a series of icons to make interpretation easier. The following explains what each icon represents.

DESIGN FEATURES

RUSTIC

This design feature refers to the various patterns in the wood itself, such as fissures and marks. Their mission is to achieve the realistic finish of natural wood.

	Without knots
	Knots
	Fissures or marks

NATURE RICH

This design feature consists of playing with different effects of timber and/or different colour intensities of the planks by zones. The result is a balanced variation in your floor that emphasises the richness of the wood.

	With Nature Rich Homogeneous
	Without Nature Rich: Homogeneous

PLANK DESIGN

Single plank	Two planks	Three planks	Chevron
Tile	Multi-width	Multi-format installation	

TYPE OF BEVEL

	Non-bevelled		4 MV Micro-bevels on four sides
--	--------------	--	------------------------------------

Color
chart

Colour code and design name — **366B Sweetness Vera Oak**
 Finish — Wood Impression

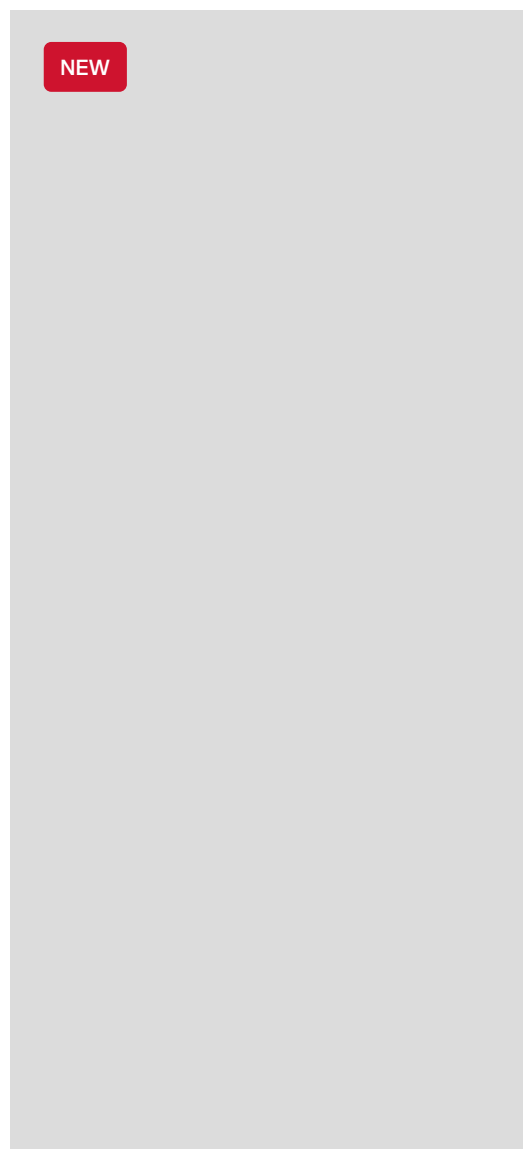

Type of bevel —

Plank design — Rustic

Multi-format installation Nature Rich

Ask us for a sample if you need one!

Keep in mind that these colour images are not exact and there may be some differences with respect to the originals.

EVOLVE | 1331 x 194 x 8 mm

9AL White Kalmar Oak
Wood Impression



8AK Albar Kalas Oak
Wood Impression



343B Brisa Fado Oak
Wood Impression



352B Essence Kalmar Oak
Wood Impression



7AK Sand Kalas Oak
Wood Impression



336B Fado Gavia Oak
Wood Impression



1AM Natural Wexford Oak
Wood Impression



EVOLVE | 1331 x 194 x 8 mm

36X Twilight Oak
Wood Impression



313B Pardo Kalas Oak
Wood Impression



339B Sotavento Fado Oak
Wood Impression



2AM Natural Arles Oak
Wood Impression



341B Tavira Fado Oak
Wood Impression



361B Golden Viena Oak
Wood Impression



2AN Toasted Wexford Oak
Wood Impression



EVOLVE | 1331 x 194 x 8 mm

23W Belle Epoque Winter
Dover



69X Concrete
Dover



3AN Grey Kalmar Oak
Wood Impression



312B Noz Kalas Oak
Wood Impression



0AM Dark Arles Oak
Wood Impression



9AK Bruno Kalas Oak
Wood Impression



XL | 1780 x 246 x 10 mm

279B Grey Eyre Oak
Wood Impression



2AL Beige Eyre Oak
Wood Impression



1AK Vanilla Eyre Oak
Wood Impression



8AJ Honey Eyre Oak
Wood Impression



6AJ Coffee Eyre Oak
Wood Impression



XL | 1780 x 246 x 10 mm

365B Clarity Vera Oak
Wood Impression



369B Century Vera Oak
Wood Impression



366B Sweetness Vera Oak
Wood Impression



368B Tribute Vera Oak
Wood Impression



367B Legacy Vera Oak
Wood Impression



12 | 1331 x 194 x 12 mm

8AK Albar Kalas Oak
Wood Impression



343B Brisa Fado Oak
Wood Impression



352B Essence Kalmar Oak
Wood Impression



336B Fado Gavia Oak
Wood Impression



339B Sotavento Fado Oak
Wood Impression



2AM Natural Arles Oak
Wood Impression



361B Golden Viena Oak
Wood Impression



2AN Toasted Wexford Oak
Wood Impression



12 | 1331 x 194 x 12 mm

313B Pardo Kalas Oak
Wood Impression



36X Twilight Oak
Wood Impression



3AN Grey Kalmar Oak
Wood Impression



312B Noz Kalas Oak
Wood Impression



SUPREME | 1310 x 240 x 8 mm

70U Santorini Tango Ash
Wood Impression



283B Sable Selena Oak
Wood Impression



5AK Raw Selena Oak
Wood Impression



9AP Orleans Chevron
Vintage Matt



42S Loreto Gaia Oak
Wood Impression



9AJ Golden Selena Oak
Wood Impression



3AK Toasted Selena Oak
Wood Impression



37S Dolomites Gaia Oak
Wood Impression



SUPREME | 1310 x 240 x 8 mm

281B Dijon Chevron
Vintage Matt

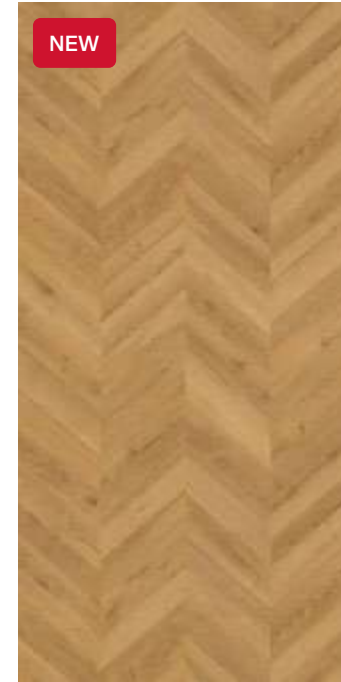

282B Nantes Chevron
Vintage Matt



39S Dalmata Gaia Oak
Wood Impression



51X Paradise Oak
Saw Cut



45U Alsace Tango Ash
Wood Impression



38S Victoria Gaia Oak
Wood Impression



43U Etna Tango Ash
Wood Impression



STYLE | 1310 x 132 x 8 mm

90H Artic Sovereign Oak
Wood Impression

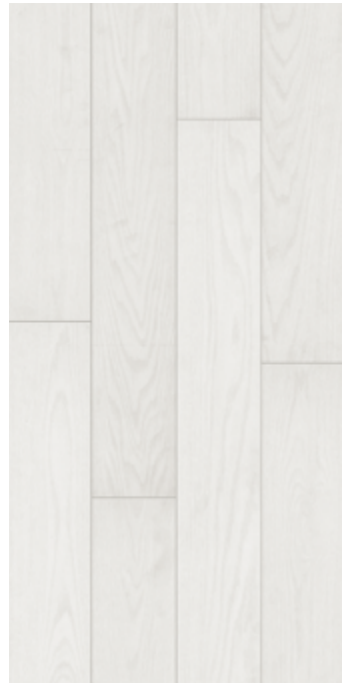

5AK Raw Selena Oak
Wood Impression



283B Sable Selena Oak Wood Impression



89H Silver Sovereign Oak
Wood Impression



78D Natural Sovereign Oak
Wood Impression



25Y Quercus Oak
Dry Touch



70N Golden Guadiana
Nature



03F Brazilian Afzelia
Nature



STYLE | 1310 x 132 x 8 mm

95N Breno Oak
Dry Touch



9AJ Golden Selena Oak
Wood Impression



3AK Toasted Selena Oak
Wood Impression



94N Magno Oak
Dry Touch



81D Merbau Classic
Nature



49X Majestic Walnut
Nature



ORIGINAL | 1331 x 194 x 8 mm

825B ~~Bobbe Loro~~

Tibet



824B ~~Milad Mado~~

Tibet



814B ~~Bobbe Saida~~

Tibet



694B Serenade Alba

Tibet



353B ~~Bobbe Sakta~~

Tibet



813B ~~Rimpo Dorje~~

Tibet



821B ~~Bobbe Saina~~

Tibet



02N ~~Robbe Otak~~

Dry Touch



ORIGINAL | 1331 x 194 x 8 mm

24T ~~Bobbe Saida~~

Tibet



322B ~~Majer Majari~~

Tibet



79N ~~Bobbe Gador~~

Dry Touch



31X ~~Bobbe Qadaque~~

Tibet



52X ~~Bobbe Ejeo~~

Vintage Matt



323B ~~Bobbe Saida~~

Tibet



822B ~~Bobbe Aira~~

Tibet



823B Mencia

Luxor



ORIGINAL | 1331 x 194 x 8 mm

46X Banff Oak

Tibet



78N Chic Oak

Dry Touch



89N Calcic Oak

Dry Touch



77N Titanio Oak

Dry Touch



324B Minueto Walnut

Vintage Matt



80N Retro Oak

Dry Touch



22P Paramount Oak

Tibet



87N Vintage Oak

Dry Touch



11/2025

Reproduction of the designs shown may not be accurate due to the technical limitations of printing. Request samples to verify actual shade. actual shade.



Finfloor

www.finfloor.com

Finsa

www.finsa.com